

17 861 875



- 146mm projection
  - rigid, thermally insulated spout
  - laminar flow
  - height of mixer 288 mm
  - height up to laminar flow regulator 180 mm
  - hole diameter 35 mm
  - provides filtered, hot water up to 93°C
  - provides filtered, cold water
  - max. flow 2 l/min at 3 bar flow pressure
  - ready-to-use control unit for wall mounting (137mm x 159mm x 60mm)
  - electronic magnetic valve
  - 100-230 V, 50-60 Hz, 18 W power supply unit, incl. country-specific adapter set
  - lead-free
  - Spout ring cannot be removed.
  - This product can help a building meet the requirements of Green Building Rating Systems, e.g. LEED®, BREEAM®, DGNB
- A minimum flow pressure of 3 bar is necessary for the HOT & COLD WATER DISPENSER to work perfectly in conjunction with a hot water tank and filter.**  
**In addition, the installation must be above a kitchen sink.**  
**The filter cartridge must be changed every six months. The installation instructions contain further information for guidance.**  
**Detailed planning information and technical data can be found at [www.dornbracht.com/professional](http://www.dornbracht.com/professional)**

A minimum flow pressure of 3 bar is necessary for the HOT & COLD WATER DISPENSER to work perfectly in conjunction with a hot water tank and filter.

In addition, the installation must be above a kitchen sink.

The filter cartridge must be changed every six months. The installation instructions contain further information for guidance.

Detailed planning information and technical data can be found at [www.dornbracht.com/professional](http://www.dornbracht.com/professional)

	Chrome	17 861 875-00
	Brushed Platinum	17 861 875-06
	Platinum	17 861 875-08
	Durabrand (23kt Gold)	17 861 875-09
	Dark Chrome	17 861 875-19
	Brushed Durabrand (23kt Gold)	17 861 875-28
	Matte Black	17 861 875-33
	Brushed Champagne (22kt Gold)	17 861 875-46
	Champagne (22kt Gold)	17 861 875-47
	Brushed Chrome	17 861 875-93
	Brushed Dark Platinum	17 861 875-99

**Required miscellaneous**



**Hot water tank incl. filter - 12 893 970 90**

17 861 875

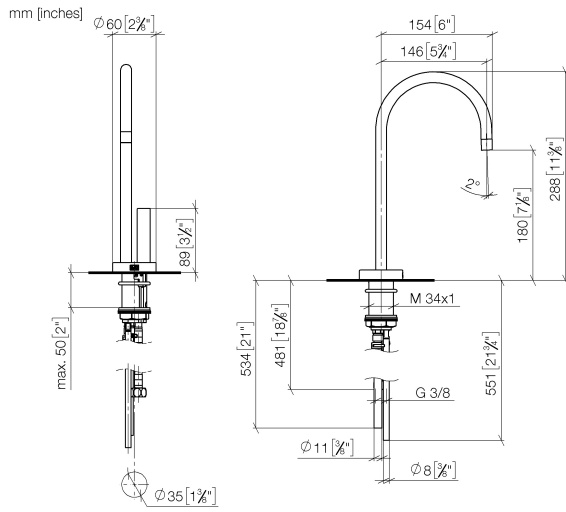

Flow rate chart

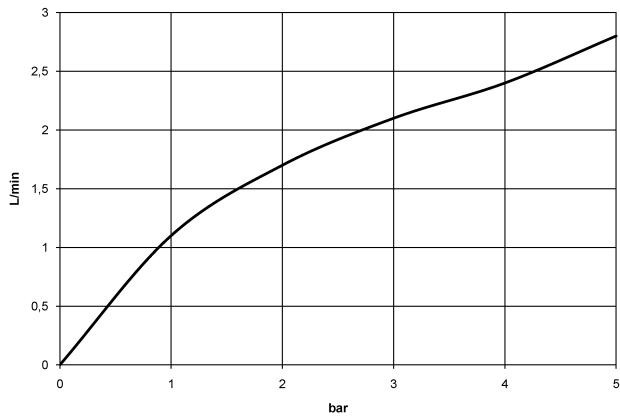

Certificates

IAPMO\_4976 (5). IAPMO\_N-4976. GDV\_0400297. LGA\_28297. IAPMO\_6397.

17 861 875

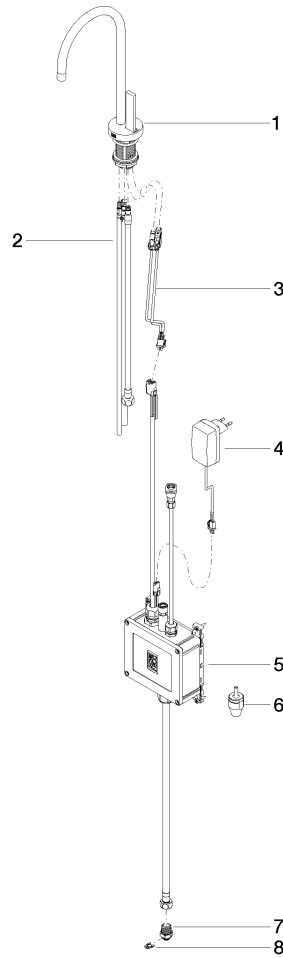

Spare parts list

No.	Item Number	Name	Quantity used	Delivery time
1	90 17 85 100 05-00	fitting	1	10
2	90 30 04 067 00 90	hose	1	2
3	90 10 01 048 00 90	electronic accessories	1	2
4	04 10 01 050 00 90	power supply	1	60
5	90 11 11 064 01 90	electronic accessories	1	2
6	90 24 04 291 00 90	insert	1	2
7	09 24 04 293 90	nipple	1	2
8	09 16 01 045 90	ring	1	2